

MetroX 3D Scanner

Quick Start Guide

V1.3

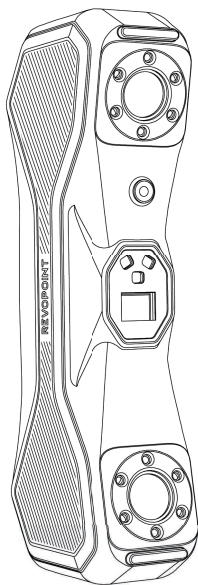

REVOPOINT

Thank you for choosing a Revopoint 3D scanner! Please carefully read this Quick Start Guide before your first scan.

Begin by downloading the **Revo Scan 5 MetroX** software for your PC from the Support – Download section on Revopoint's website at www.revopoint3d.com for your MetroX 3D Scanner.

Go to the bottom of the Download page to get the latest Quick Start Guide. You can also follow our YouTube account, Revopoint 3D, for tutorial videos. This content is subject to change. Please refer to the latest version.



Please keep the scanner away from water and other liquids, and avoid bashing the scanner.

This product's operating environment temperature range is 0°C to 40°C (32°F to 104°F). Please use the product only within this range.

Contents

What's in the Box	1
Product Profile	2
System Requirements	3
Connecting MetroX to a PC	3
Scanning Modes Introduction	4
Scanning Tips	4
Your First Scan	5
Scanner Calibration	8
IC Warning	9
FCC Warning	9

What's in the Box

1



MetroX 3D Scanner

2

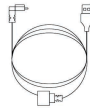

USB Type-A to
Type-C Cable

3

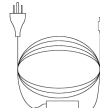

Power Adapter

4

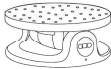

Dual-axis Turntable

5

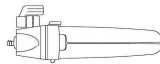

Tripod

6

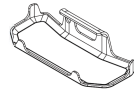

Scanner Cradle

7



Markers

8

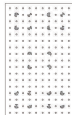

Calibration Board

9



USB Type-C to
Type-A Adapter

10



Wrist Strap

11



Carrying Case

12



Sample Bust

13



Quick Start Guide
Certificate & Warranty Card

*For reference only.

Note: The Power Adapter may vary depending on the country or region.
Some accessories are behind the top padding.

Product Profile

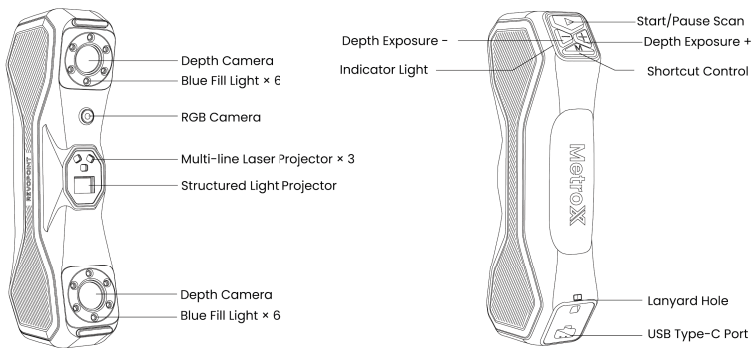

Indicator Light States

Green flash once	Power on
Red and flashing	Powering up
Green always on	Powered
Green and flashing	Operating normally

Button Functions

	Start/Pause Scan
	Increase depth camera exposure
	Decrease depth camera exposure
	Zoom in/Zoom out Central Preview Window or Custom Settings

System Requirements

Before your first scan, please download the Revo Scan 5 MetroX software on Revopoint's website at www.revopoint3d.com. The system requirements are as follows:

Minimum PC Requirements

Windows

System Version: Windows 10/11 (64-bit)
 RAM: ≥ 32 GB
 CPU: Intel i7 10th Gen 10700 or AMD Ryzen 7 5800
 GPU (Optional): NVIDIA GeForce RTX 3050 (8 GB)

macOS

System Version: macOS 11.0 or better
 RAM: ≥ 16 GB
 CPU: M1 Pro/Max/Ultra

Recommended PC Requirements

Windows

System Version: Windows 10/11 (64-bit)
 RAM: ≥ 64 GB
 CPU: Intel i9 12th Gen or better
 GPU: NVIDIA RTX 4060 (8 GB) or better

macOS

System Version: macOS 11.0 or better
 RAM: ≥ 24 GB
 CPU: M2 Pro/Max/Ultra, M3 Pro/Max/
 Ultra

Note: If you're unsure about the CPU configuration, please ensure that the CPU has cores ≥ 8 , threads ≥ 16 , and a base frequency ≥ 2.4 GHz. Please ensure the USB port on your PC is USB 3.0 or above.

Connecting MetroX to a PC

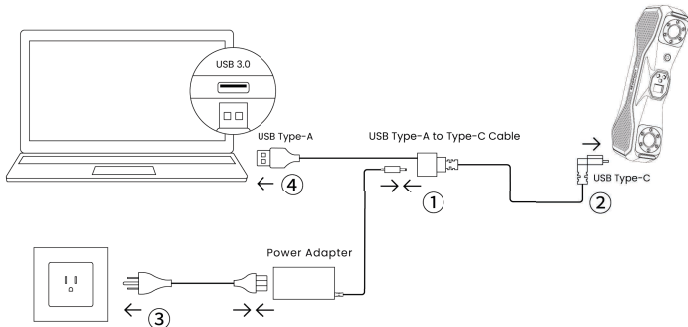

1. To power the scanner, follow steps 1 to 3.
2. To connect to a PC, follow step 4 and plug it into a USB 3.0 Type-A port on your PC. If your PC doesn't have one, use the USB Type-C to Type-A adapter.

Note: If the connection fails or the frame rate drops below 10 fps, disconnect from the PC while keeping power on. Then, repeat step 4 to reboot the device.

Scanning Modes Introduction

- ① **Cross Lines:** Designed for capturing shiny metals and black objects. It's more efficient than Parallel Lines mode. (Requires markers for tracking.)
- ② **Parallel Lines:** Designed for capturing fine and complex details at a lower speed. (Requires markers for tracking.)
- ③ **Full Field:** Designed for efficiently capturing feature-rich objects in a short time.
- ④ **Auto Turntable:** The turntable, scanner, and Revo Scan 5 MetroX work together to automatically scan an object in single-shot mode, streamlining the process and generating a detailed, color-accurate 3D model if required.

Scanning Tips

- ① Please operate the scanner at room temperature around 20 °C . After powering on MetroX, wait 10 minutes for it to warm up for better scanning results.
- ② Scan indoors and ensure only the object being scanned is shown in the Depth Cameras' preview window.

- ③ When choosing Marker Scan, stick markers irregularly on the object, ensure at least 5 markers can be detected in a single frame during the scan. In Revo Scan 5 MetroX's scan settings, choose Full Field, Cross Lines, Parallel Lines, or Auto Turntable. **For best accuracy, attach the markers to flat surfaces rather than curved ones. Also, please avoid using soft pads or cloths with markers.**

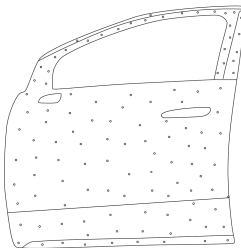

- ④ When choosing Feature Scan, you can choose Full Field or Auto Turntable in Scan Settings – Scan Mode.
- ⑤ This product has a Class 2M laser projector. Avoid looking directly at the laser up close, and do not use magnifying tools like telescopes or cameras to view the beam, as it can damage your retina. Keep reflective surfaces such as mirrors and glass away from the laser beam's path.

When Objects Need to Be Treated With Scanning Spray Before Scanning

Object Type \ Scanning Mode	Cross Lines/Parallel Lines	Full Field/Auto Turntable
Matt Black Objects	No	No
Shiny Black Objects	No	Yes
Matt Metal Objects	No	No
Shiny Metal Objects	No	Yes
Transparent Objects	Yes	Yes
Specular Objects	Yes	Yes
Other Shiny Objects	No	Yes

Note: Scanning spray can be purchased from Revopoint's online stores.

Your First Scan

Handheld Scanning Scenario: Cross Lines/Parallel Lines/Full Field

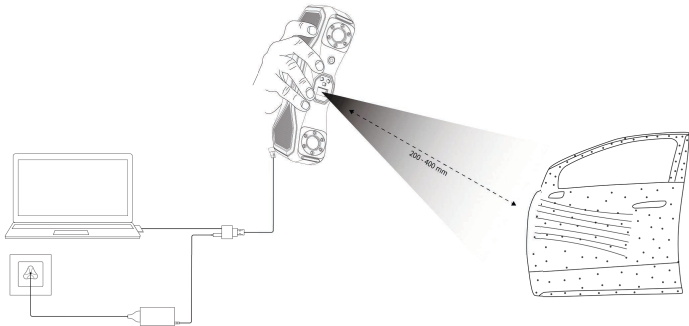

After the scanner is connected, click the **New Project** button on Revo Scan 5 MetroX's Home page to enter Marker Scan page (or click the icon in the upper left corner to switch to Feature Scan), then set parameters and start your scan using the following steps:

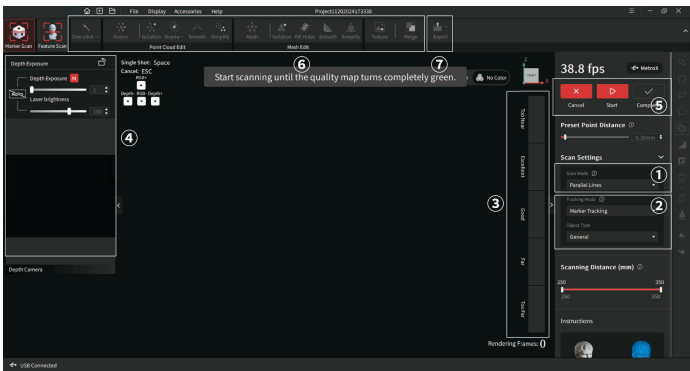

※ Please refer to the actual interface in Revo Scan 5 MetroX.

- ① In Scan Settings, choose Cross Lines, Parallel Lines, or Full Field mode. In laser line scanning modes (Cross Lines and Parallel Lines modes), please set the scanning point distance before scan.
- ② Choose Object Type according to your requirements.
- ③ Move the scanner closer or further away from the object until the scanning distance indicator bar shows **Excellent** or **Good**.
- ④ Click the button to automatically set the Depth Cameras' exposure, or turn off the Auto exposure () and adjust it by dragging the slider until there are as few blue and red areas on the object in the Depth Camera preview window as possible and the whole object shows gray.
- ⑤ Click the button to begin your scan. During the scan, aim the scanner at the object, move the scanner slowly and steadily around the object, and keep the distance between the scanner and the object at 250 - 350 mm. In the 3D scanning interface in Revo Scan 5 MetroX, refer to the distance indicator bar to ensure an excellent distance. You can click the button to stop and check your model anytime during your scan. If the model is incomplete, click the button to continue your scan. Click the button to finish the scan when the model is complete.

Note: When scanning with laser line modes, the point cloud changes from red to green as more data is captured. Green indicates higher quality, so it's best to scan the same areas from different angles and finish when the model is mostly green.

- ⑥ Click **One-click Edit** to process the model automatically, or manually edit the model using the Fusion and Mesh settings, and other tools if you need a more detailed model. When manually processing for point cloud fusion, it is suggested that the system's recommended point distance be used. Setting a very small point distance will lead to a long calculation time. For details, please refer to the User Manual on Revo Scan 5 MetroX's Learning page.
- ⑦ After post-processing, export the model in formats such as PLY, OBJ, or STL.

Desktop Scanning Scenario: Auto Turntable

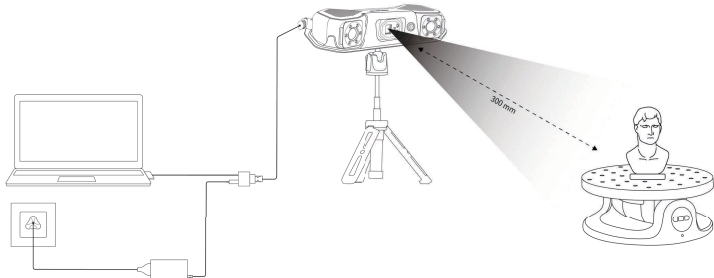

- ① Attach the scanner cradle to the tripod, put the scanner on it, adjust the tripod to a suitable height, and place it on a stable surface. It is strongly recommended that you fix the object on the turntable and not move the scanner, turntable, and the object during the scan.
- ② After connecting the scanner, click the **New Project** button on the Home page to enter Marker Scan page (or click the icon in the upper left corner to switch to Feature Scan).
- ③ Use the power cable to power the turntable.

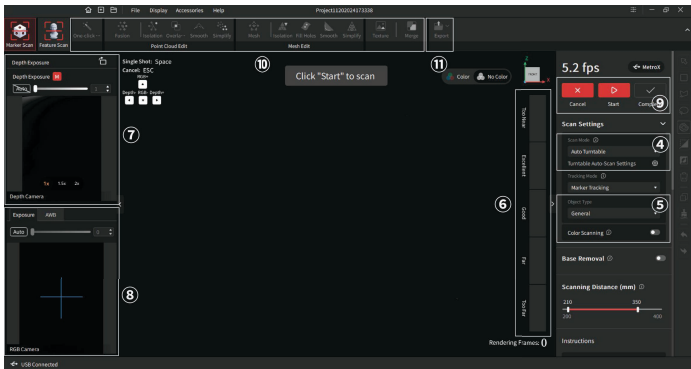

※ Please refer to the actual interface of Revo Scan 5 MetroX.

- ④ Choose Auto Turntable mode in **Scan Settings**. Click the Settings button to connect the turntable and set the rotation direction, interval, and total rotations. Beginners can use the default settings.
- ⑤ Choose Object Type according to your requirements. Only the Auto Turntable mode supports color scanning. If required, toggle Color Scanning and ensure the object is evenly lit during scanning.
- ⑥ Move the scanner closer or further away from the object until the scanning distance

indicator bar shows **Excellent** or **Good**.

- ⑦ Click the button to automatically set the Depth Cameras' exposure, or turn off the Auto exposure () and adjust it by dragging the slider until there are as few blue and red areas on the object in the Depth Camera preview window as possible and the whole object shows gray.
- ⑧ You also must adjust the RGB Camera's exposure when doing a color scan. Click the button to automatically set the exposure, or turn off the Auto exposure () and adjust it by dragging the slider until the object's color in the RGB preview window is clear and sharp.
- ⑨ Click the button, and the software will control the turntable to automatically finish the scan with single-shot mode according to your settings. If the model is incomplete, click the button to continue your scan after resetting the scan path. Click the button to finish the scan when the model is complete.
- ⑩ Click **One-click Edit** to process the model automatically, or manually edit the model using the Fusion, Mesh, Texture (only for color models) settings, and other tools if you need a more detailed model. When manually processing for point cloud fusion, it is recommended to use the system's suggested point distance. Setting a very small point distance will lead to a long calculation time. For details, please refer to the User Manual on Revo Scan 5 MetroX's Learning page.
- ⑪ After post-processing, export the model in formats such as PLY, OBJ, or STL.

Scanner Calibration

Users can recalibrate the scanner using the Scanner Calibration program on Revo Scan 5 MetroX's Home page to ensure accuracy. The scanner was professionally calibrated at the factory. **Before scanning, please check the scanner's accuracy first after entering the calibration program** and calibrate the scanner according to the on-screen instructions if needed. Please ensure the computer is connected to a power supply during calibration. You can calibrate the scanner as follows:

- ① Download the latest version of Revo Scan 5 MetroX from the Support – Download section on Revopoint's website at www.revopoint3d.com and open it.
- ② Power the scanner and connect it to a USB 3.0 port on a PC using the USB Type-A to Type-C Cable and power adapter that came with your scanner.
- ③ When the software interface shows Scanner Connected, click [Scanner Calibration] on the bottom left corner of Revo Scan 5 MetroX's Home page to enter the calibration process.
- ④ Complete the accuracy check and calibration in sequence according to the on-screen instructions.

IC Warning

This device complies with Industry Canada's license-exempt RSS standard (s). Operation is subject to the following two conditions:

- (1) this device may not cause interference, and
- (2) this device must accept any interference, including interference that may cause undesired operation of the device.

This Class B digital apparatus complies with Canadian ICES-003.

IC RF Statement:

When using the product, maintain a distance of 20cm from the body to ensure compliance with RF exposure requirements.

FCC Warning

This device complies with part 15 of the FCC Rules. Operation is subject to the following two conditions:

- (1) This device may not cause harmful interference, and
- (2) this device must accept any interference received, including interference that may cause undesired operation.

Any Changes or modifications not expressly approved by the party responsible for compliance could void the user's authority to operate the equipment.

Note: This equipment has been tested and found to comply with the limits for a Class B digital device, pursuant to part 15 of the FCC Rules. These limits are designed to provide reasonable protection against harmful interference in a residential installation. This equipment generates uses and can radiate radio frequency energy and, if not installed and used in accordance with the instructions, may cause harmful interference to radio communications. However, there is no guarantee that interference will not occur in a particular installation. If this equipment does cause harmful interference to radio or television reception, which can be determined by turning the equipment off and on, the user is encouraged to try to correct the interference by one or more of the following measures:

- Reorient or relocate the receiving antenna.
- Increase the separation between the equipment and receiver.
- Connect the equipment to an outlet on a circuit different from that to which the receiver is connected.
- Consult the dealer or an experienced radio/TV technician for help.

This equipment complies with FCC radiation exposure limits set forth for an uncontrolled environment.

This equipment should be installed and operated with a minimum distance of 20cm between the radiator & your body.

Follow Us:



Contact Us:



Scan the QR code with your
phone to contact us.